

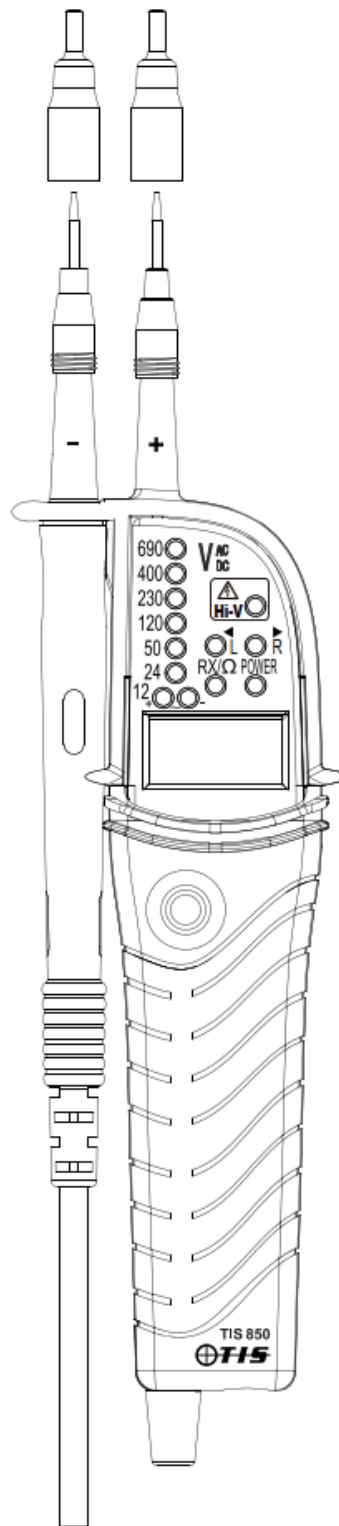

TIS 850



1. FEATURES

- Self diagnostic test
 - AC and DC voltage tests up to 690V for Europe with LED and LCD
 - Polarity indication
 - Phase rotation test
 - Continuity test
-

- Auto power ON/OFF
- Pen light for illuminating measurement points
- Probe clip for adjustable spacing between probes
- Probe cover protects user and probe tips
- IP 64
- Compact design, light weight and portable
- H07RNF compliant cable in accordance with European standards

2. Safety warning

This instruction manual contains warnings and safety rules which must be observed by the user to ensure safe operation of the instrument and to maintain it in a safe condition. Therefore, please read through these operating instructions before using the instrument.

 **WARNING** is reserved for conditions and actions that are likely to cause serious or fatal injury.

 **CAUTION** is reserved for conditions and actions that can cause injury or instrument damage.

It is essential that this set of instructions is adhered to.
Failure to follow these instructions may cause serious injury, death, instrument damage and/or damage to equipment under testing.

WARNING

- Never take measurements on a circuit in which the electrical potential exceeds 690V. (If the measured voltage exceeds 690V, all the voltage display LEDs light up).
- After measuring AC/DC voltage for 3 minutes, the tester must not be used for 1 minute immediately afterwards.
- Do not attempt to take measurements in the presence of flammable gases, as the use of the instrument may cause sparking, which could lead to an explosion.
- Never attempt to use the instrument if its surface or your hands are wet. (Do not use when it is raining).
- Keep your hands and fingers behind the barriers during measurements.
- Never unlock and open the battery case during measurements.
- Always verify proper operation on a known source before taking action as a result of the indication. The unit must be proved before and after operation in accordance with safe isolation procedures.
- Never attempt to make any measurement in any abnormal conditions, such as a broken case or exposed metal parts are present on the instrument or test probes.
- Do not make any modification to the instrument.
- Extreme caution and danger when live circuit LED flashes or lights up.
 - Correct indication of LEDs is only guaranteed within a temperature range of -10°C up to 55°C (<85% RH)

3. Instrument layout

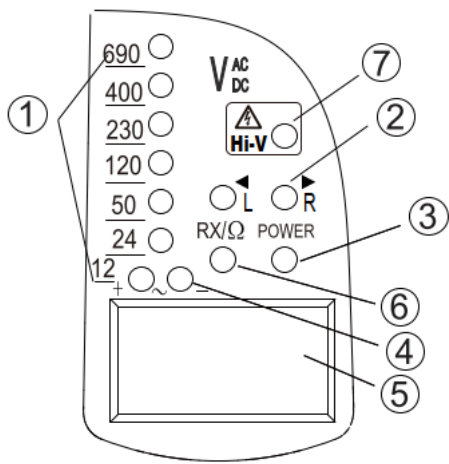

- 1 12/24/50/1 20/230/400/690V LEDs.for European voltage indication
- 2 L/R LEDs for phase rotation test
- 3 Power LED
- 4 Polarity indication LEDs for voltage
- 5 LCD
- 6 Continuity test /Live circuit LED
- ⚠7 Hight voltage indication > 50V, LED will light up

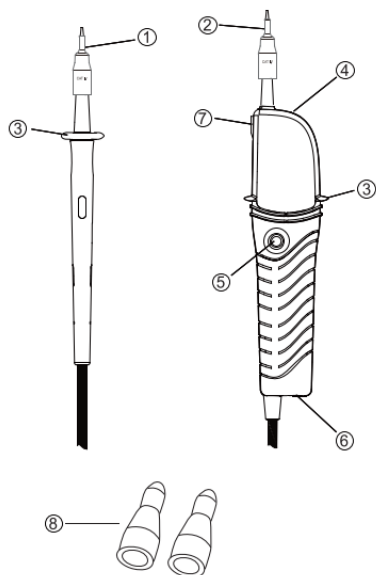

- (1). L1 probe -
- (2). L2 probe + (Instrument probe)
- (3). Barrier
- (4). Pen light
- (5). Pen light switch
- (6).Battery case
- (7). Probe clip
- (8). Probe protection cover

4. Preparation for Measurement

4.1 Auto Power-on / Self Diagnostic Test

- Auto Power-on
- Short-circuiting the probes as follows powers on the instrument automatically and goes into a self-diagnostic test.

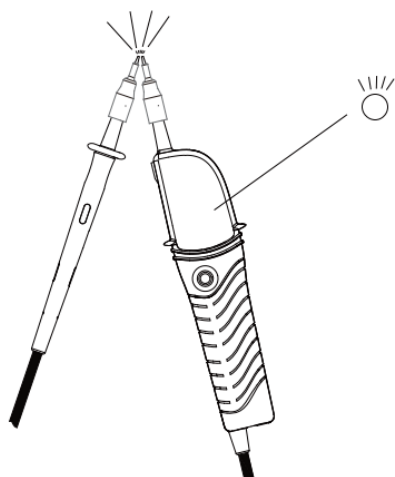

Instrument may power on due to the influence of static charge.
ALWAYS PROVE THIS TESTER ON A KNOWN LIVE SOURCE BEFORE AND AFTER TEST.

■ Self-diagnostic test

	<p>WARNING Do not use the instrument if abnormality is found during self-diagnostic test.</p>
---	---

◆ Battery voltage is normal when

power LED lights up.

When the battery voltage is below $2.4 \pm 0.1V$, the power LED flashes or goes off.
 Replace batteries according to section 7.

4.2 Trouble shooting

If the following problems occur, unlock the battery case according to section 7 in this manual, and then lock it again 5 seconds later. Then perform the self-diagnostic test (section 4.1).

- Self-Proving Test cannot be performed before/after use of the instrument.
- Automatic power-off does not operate.

5. Single handed use

With the L1 probe on the probe clip, the user can change the spacing between probes with one hand.

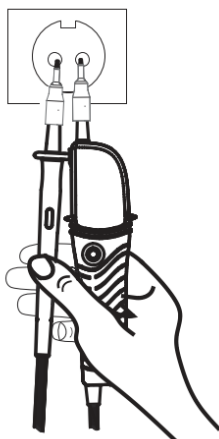

6. Measurement

1. Voltage test (Double-pole test)



WARNING

- Carefully check Clause 2 also.
- Self-diagnostic test should be done prior to measurements to confirm that LEDs and buzzer work properly.
- Before using a voltage tester with audible indication, please make sure that the background noise level is not such that the tester audible output cannot be heard.
- Verify proper operation on a known source before and after use.
- Keep your hand and fingers behind the barriers on the probes during measurements.



- ▶ Connect both probes to the object under test.
- ▶ The voltage is indicated by LEDs and LCD.

Live circuit LED lights up: $\geq 7V$

- ▶ Voltage polarity is indicated in following manner.

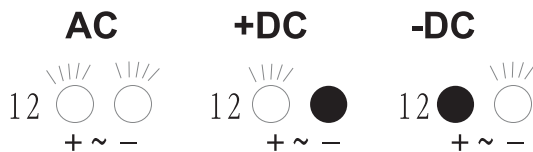

NOTE

- When the L2 probe + is the positive (negative) potential, the Polarity indication LED indicates "+DC" ("-DC").

2. High voltage indication

- ▶ Hold the instrument firmly and connect both probes to the object under test.
- ▶ Live circuit LED  lights up when a voltage of approx. 50V AC or more exists in the object under test. (Pol > 50V AC)

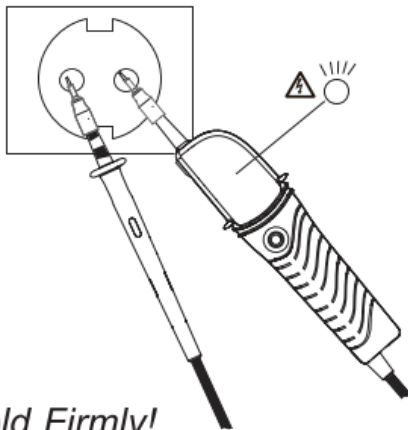

Hold Firmly!

3. Phase rotation test

L LED and R LED for Phase rotation test may operate on various wiring systems, but effective testing result can be obtained only on Three phase system.

- ▶ Hold the instrument firmly and connect both probes to the object under test. (Holding method show as below fig.)
- ▶ Phase-to-phase voltage is indicated by each Voltage LED.
- ▶ R LED indicates that the field is rotating towards the right direction of the "probe -". With this connection, the motor will go positive rotation.

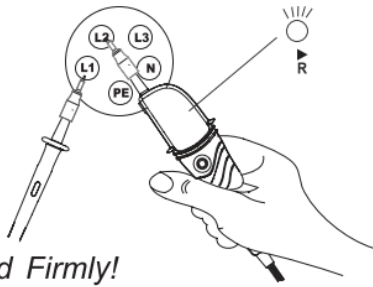

Hold Firmly!

- L LED indicates that the field is rotating towards the left direction of the “probe -”. With this connection, the motor will go negative rotation.

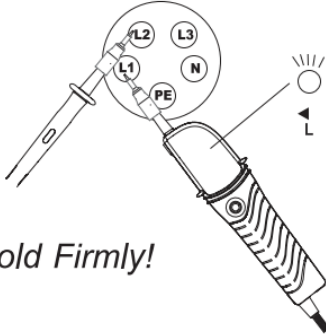

Hold Firmly!

The principle of measurement

The instrument detects the phase rising order in relation to the user to EARTH.

NOTE

Function of this test may not be fully achieved if the insulation condition of the user or of the equipment under test is not good enough.

6.4 Continuity test



WARNING

Make sure the object under test isn't live.

Instrument operates as follows when measuring

continuity.

- LED RX/Ω should be lighted, and the buzzer should sound continuously.

NOTE

In continuity mode the instrument works in the same way as the self-diagnostic test.

6.5 Pen light function

(Illuminating the test Point)

Integral pen light illuminates the measurement point in dimly lit areas.

- Pushing the Pen light switch turns on the light.

NOTE

- The light is available while the instrument is powered off.
- Using the Pen light shortens the battery life.

7. Battery Replacement



WARNING

Remove the probes from any testing point when opening the Battery case.

Batteries are dead when Power LED flashes or goes off at Self-diagnostic test defined in point 4.1. Follow the procedure below and replace batteries with new ones (type AAA 1.5 x 2pcs).

- Unlock the Battery case with a coin-shaped object.



Close



Open

- ▶ Pull out the Battery case and replace the batteries. Insert new batteries according to the symbols on the Battery case.
- ▶ Insert the Battery case into the instrument and firmly lock the case again.



WARNING

Confirm that the Battery case is properly locked prior to measurements.

8. Specifications

Voltage test	
Voltage range	12 ~ 690V AC/DC
LED	
Nominal voltage	12/24/50/120/230/400/690V
Tolerance (Threshold voltage)	Light on at more than 7±5V (12V LED) 18 ±5V (24V LED) 37.5±5V (50V LED) 75% ± 5% of nominal voltage (120/230/400/690V LED)
Response time	<0.5s at 100% of each nominal voltage
LCD	
Range resolution (auto-range)	7 ~ 690V/1V
Accuracy (23±5°C)	±(3%+3) or 5V
Over range indication	All voltage LED light up
Response time	<1s at 90% of each voltage
Peak current is	3.5mA (at 690V)
Internal battery consumption	Approx. 33mA (battery 3V, measuring 690V AC)
High voltage indication	
Voltage range	50 ~ 690V AC
Phase rotation test	
System	Three-phase system / AC 50/60Hz
Phase range	120 ± 5 degrees
Continuity test	
Detection range	0 ~ 550kΩ
Test current	Approx. 1.5μA (battery 3V, 0Ω)
Internal battery consumption	Approx. 30mA (battery 3V, 0Ω)

Reference condition	
Battery	3V (AAA 1.5V x 2pcs)
Temperature	-10 ~ 55°C Operation -20 ~ 60°C Storage No condensation
Humidity	Max. 85% RH
Operating altitude	Altitude up to 2000m
Safety	
Standard category	EN 61243-3/ IEC 61243-3 EN 61010-1/ IEC 61010-1 CATIII 690V /CAT IV 600V
Pollution degree	2
IP code	IP64

9. Cleaning and Storage



CAUTION

- Use a lightly damp cloth with neutral detergent for cleaning the instrument. Do not use abrasives or solvents.
- Do not expose the instrument to direct sunlight, high temperatures and humidity or dew.
- Put the probe protection cover on the tips while not in use. Otherwise, it may cause injury.
- Remove batteries when the instrument is not being used for a long period.
- Do not install the battery case without batteries.
- Please operate this unit strictly according to these instructions.

10. Safety Symbol



Always check proper operation of the device on a known working circuit before using.



Suitable for live working.



Caution! Risk of electric shock. Under normal use, hazardous voltages may be present.



Alternating current.



Both direct and alternating current.

11. Measurement Category

Category IV: is for measurements performed at the source of the low-voltage installation.

Category III: is for measurements performed in the building installation.

n

12. For Environment



- Do not dispose electrical appliances as unsorted municipal waste, use separate collection facilities.
- Contact your local government for information regarding the collection systems available.
- If electrical appliances are disposed of in landfills or dumps, hazardous substances can leak into the ground water and get into the food chain, damaging your health and well-being.
- When replacing old appliances with new ones, the retailer is legally obligated to take back your old appliance for disposal at least for free of charge.

13. Ingress protection (IP) ratings

Ingress protection numbers are used to specify the environmental protection – electrical enclosure – of electrical equipment.

The IP rating normally has two numbers:

1. The first number – protection against solid objects.
2. The second number – protection against liquids.

IP64:

The instrument is totally protected against dust and against water sprayed from all directions.
