

AC/DC Clamp Meter

User's Manual

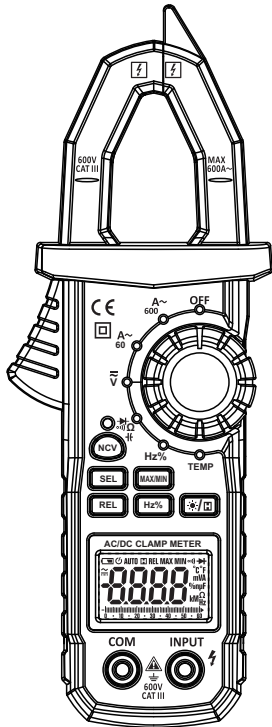

AC/DC Clamp Meter

CONTENTS

1. Safety Information.....	1
1.1 Preparation.....	1
1.2 Usage.....	2
1.3 Signs and Labels.....	3
1.4 Maintenance.....	4
2. Description.....	4
2.1 Part Name.....	5
2.2 Switch and Button Description.....	7
2.3 LCD Display.....	8
3. Specification.....	9
3.1 General.....	9
3.2 Technique Data.....	9
4. Operating guidance.....	15
4.1 Reading Hold.....	15
4.2 Measuring Range Switch.....	15
4.3 Frequency/Duty Ratio Switch.....	15
4.4 Maximum/Minimum Measurement Choice.....	16
4.5 Function Choice.....	17

AC/DC Clamp Meter

CONTENTS

4.6 Relative Measurement and Surge Measurement.....	17
4.7 Back Light and Clamp Head Light.....	17
4.8 Automatic Power-Off.....	18
4.9 Measurement Preparation.....	18
4.10 Current Measurement.....	19
4.11 Voltage Measurement.....	20
4.12 Frequency and Duty Ratio Measurement.....	21
4.13 Resistance Measurement.....	23
4.14 Diode Test.....	24
4.15 Circuit Continuity test.....	24
4.16 Capacitance Measurement.....	25
4.17 NCV Measurement.....	26
4.18 Temperature Measurement.....	26
5. Maintenance.....	27
5.1 Replace Battery.....	27
5.2 Replace Probe.....	27
6. Accessories.....	27

AC/DC Clamp Meter

1. Safety Information

Warning

Please particularly note that inappropriate use may cause shock or damage to the meter. When using the meter, comply with common safety procedures and completely follow the safety measures in this operation manual.

To make full use of the meter's functions and ensure safe operation, please carefully read and follow the procedures in the operation manual.

This meter is designed and manufactured according to safety requirements of EN 61010-1, EN 61010-2-032, EN 61010-2-033 concerning electronic measuring instruments with a measurement CAT III 600V and pollution degree 2 and safety requirements for hand-held clamps for electrical measurement and test.

With proper use and care, this digital multimeter will give you years of satisfactory service.

1.1 Preparation

- 1.1.1 When using the meter, the user should comply with standard safety rules:
 - General shock protection
 - Prevent misusing the meter
- 1.1.2 After receiving the meter, please check for damage that may have occurred during transportation.
- 1.1.3 If the meter is stored and shipped under hard conditions, please confirm that the meter is undamaged.

AC/DC Clamp Meter

- 1.1.4 Probe should be in good condition. Before use, please check whether the probe insulation is damaged, whether metal wire is bare.
- 1.1.5 Use the probe table provided with the meter to ensure safety. If necessary, replace the probe with another identical probe or one with the same specification.









1.2 Usage

- 1.2.1 When using the meter, select the right function and measuring range.
- 1.2.2 Don't measure when exceeding the maximum value in each measuring range.
- 1.2.3 When measuring a circuit with the meter connected, do not touch the probe tip (metal part).
- 1.2.4 When measuring, if the voltage to be measured is more than 60 V DC or 30 V AC (RMS), always keep your fingers behind the finger protection device.
- 1.2.5 Do not measure voltage greater than AC 600V.
- 1.2.6 In the manual measuring range, when the value to be measured is not known in advance, choose the highest measuring range to begin, and then gradually select lower ranges until the correct range is identified.
- 1.2.7 Before rotating conversion switch to change measuring function, remove probe from the circuit to be measured.
- 1.2.8 Don't measure resistors, capacitors, diodes and circuits that are energized.
- 1.2.9 During the test of current, resistors, capacitors, diodes and circuit connections, do not allow the meter to connect with voltage source.

AC/DC Clamp Meter

- 1.2.10 Don't measure capacitance unless the capacitor is discharged completely.
- 1.2.11 Don't use the meter in explosive gas, vapor or dusty environments.
- 1.2.12 If you find any abnormal condition or failure on the meter, stop using the meter and have it serviced by a qualified technician.
- 1.2.13 Unless the meter bottom case and the battery cover are completely fastened in their original places, do not use the meter.
- 1.2.14 Don't store or use the meter in direct sunlight, high temperature or high humidity.

1.3 Part name

	Note-Important safety information, refer to the instruction manual.
	Application around and removal from UNINSULATED HAZARDOUS LIVE conductors is permitted.
	Caution, possibility of electric shock
	Equipment protected throughout by double insulation or reinforced insulation.
	Conforms to UL STD. 61010-1, 61010-2-032, 61010-2-033; Certified to CSA STD C22.2 NO. 61010-1, IEC 61010-2-032, 61010-2-033
	Complies with European (EU) safety standards
	Earth (ground) TERMINAL
	Direct current
	Alternating current

CAT III: MEASUREMENT CATEGORY III is applicable to test and measuring circuits connected to the distribution part of the building's low-voltage MAINS installation.

AC/DC Clamp Meter

1.4 Maintenance

- 1.4.1 Don't try to open the meter bottom case to adjust or repair. Such operations only can be made by qualified technicians who fully understand the meter and electrical shock hazard.
- 1.4.2 Before opening the meter bottom case or battery cover, remove probe from the circuit to be measured.
- 1.4.3 To avoid wrong readings and potential electric shock, when "  " appears on the meter display, replace the battery immediately.
- 1.4.4 Clean the meter with damp cloth and mild detergent. Do not use abrasives or solvents.
- 1.4.5 Power off the meter when it is not used. Switch the transfer switch to OFF position.
- 1.4.6 If the meter is not used for long time, please take the battery out to prevent the meter being damaged.

2. Description

- The meter is a portable, professional measuring instrument with LCD display and back light for easy reading by users. Measuring range switch is operated by single hand for easy operation. The meter has overload protection and low battery indicator. It is an ideal multifunction meter for professionals, factories, schools, fans and family use.
- The meter is used to measure AC current, DC current, voltage, DC voltage, frequency, duty ratio, resistance, capacitance, circuit connections, diodes, non-contact voltages and temperatures.
- The meter has an auto measuring range function.
- The meter has a reading hold function.
- The meter has a max. measuring function.
- The meter has a min. measuring function.

AC/DC Clamp Meter

- The meter has a clamp head frequency measurement function.
- The meter has an auto power-off function.
- The meter has a relative measuring function.

2.1 Part name

- (1) Current clamp head: used for current measurement.
- (2) NCV indicator
- (3) Key
- (4) LCD display
- (5) Common end jack
- (6) Resistance, capacitance, voltage, frequency, diode, continuity and temperature input jack
- (7) Knob
- (8) Clamp head center position
- (9) NCV sense position

AC/DC Clamp Meter

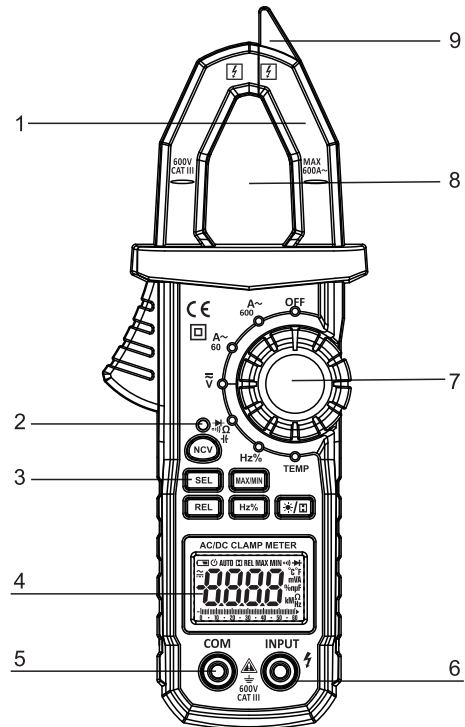

AC/DC Clamp Meter

2.2 Switch, Button and Input Jack Description

B.L/HOLD button: used for reading hold or back light control

MAX/MIN button: used for maximum/minimum measurement function switch.

SEL button: used for measuring function switch.

NCV button: Non-contact voltage detection switch.

REL button: used for entering relative measurement state.

Hz/% button: used for frequency and duty ratio measurement function switch.

OFF position: used for shutting off the power.

INPUT jack: voltage, resistance, frequency, duty ratio, capacitance, diode, circuit connection, temperature measurement input wire connecting terminal.

COM jack: voltage, resistance, frequency, duty ratio, capacitance, diode, circuit connection, temperature measurement common wire connecting terminal.

Transfer switch: used for selecting function and measuring range.

AC/DC Clamp Meter

2.3 LCD Display

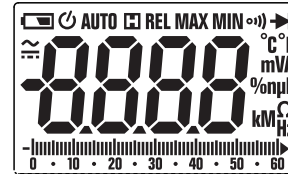

~	ALTERNATING CURRENT, direct current
▶ ◂)	Diode, continuity
AUTO	Automatic measuring range mode
MAX	Maximum measurement state
MIN	Minimum measurement state
REL	Relative measurement mode
⏻	Automatic power-off state
🔋	LOW BATTERY
H	Reading hold state
%	Percentage (duty ratio)
mV, V	Millivolt, Volt (voltage)
A	Amperes (Current)
nF, μF	Nanofarad, Microfarad
Ω, kΩ, MΩ	Ohm, Kilohm, Megohm (resistance)
Hz, kHz, MHz	Hertz, Kilohertz, Megahertz (frequency)
°C, °F	Celsius degree, Fahrenheit degree (temperature)

AC/DC Clamp Meter

3. Specifications

At least once a year, the meter should be recalibrated in temperatures of 18°C ~ 28°C and relative humidity less than 75%.

3.1 General

Auto measuring range.

Full measuring range overload protection.

The maximum allowable voltage between measurement

end and ground: 600V DC or 600V AC

Operational height: maximum 2000m

Display: LCD

Displayed maximum value: 5999 digit.

Polarity indication: automatic indication, '-' means negative polarity.

Exceeding measuring range display: '0L' or '-0L'.

Sampling rate: about 3 times/s, simulation bar 30 times/s.

Unit display: has function and power unit display.

Auto off time: 15 min

Power supply: 3x 1.5V AAA batteries

Battery undervoltage indication: LCD displays  symbol.

Temperature coefficient: less than 0.1x accuracy/°C

Operating temperature: 18°C~28°C.

Storage temperature: -10°C~50°C

Dimension: 218x78x35mm

Weight: 239g

3.2 Technical Indicators

Environment temperature: 23±5°C, relative humidity (RH): <75%

AC/DC Clamp Meter

3.2.1 AC Current

Measuring range	Resolution	Accuracy
60A	0.01A	±(2.5% of reading + 6 digits)
600A	0.1A	

- Maximum input current: 600AAC

- Frequency range: 40~400Hz

3.2.2 DC Current

Measuring range	Resolution	Accuracy
60A	0.01A	±(3.0% of reading + 6 digits)
600A	0.1A	

- Maximum input current: 600A DC

3.2.3 DC Voltage

Measuring range	Resolution	Accuracy
600mV	0.1mV	±(0.7% of reading + 2digits)
6V	0.001V	
60V	0.01V	
600V	0.1V	

- Input impedance: 10MΩ

- Maximum input voltage: 600V AC (RMS) or 600V DC

AC/DC Clamp Meter

Note:

In the small voltage measuring range, the probe is not connected with the circuit to be tested, and the meter may have fluctuating readings. This is normal and caused by the meter's high sensitivity. It does not affect actual measurement results.

3.2.4 AC Voltage

Measuring range	Resolution	Accuracy
6V	0.001V	±(0.8% of reading + 3 digits)
60V	0.01V	
600V	0.1V	
600V	1V	±(1.0% of reading + 4 digits)

- Input impedance: 10MΩ
- Maximum input voltage: 600V AC (RMS) or 600V DC
- Frequency range: 40 ~ 400Hz

3.2.5 Frequency

3.2.5.1 Clamp head measuring frequency (through grade A):

Measuring range	Resolution	Accuracy
99.99Hz	0.01KHz	± (1.5% of reading + 5 digits)
999.9Hz	0.1KHz	

- Measuring scope: 40Hz ~ 1kHz
- The input signal range: ≥ 6AAC (RMS) (input current will increase when the frequency to be measured increases)
- Maximum input current: AC 600A (RMS)

AC/DC Clamp Meter

3.2.5.2 Through grade V:

Measuring range	Resolution	Accuracy
99.99Hz	0.01Hz	± (1.5% of reading + 5 digits)
999.9Hz	0.1Hz	
9.999kHz	0.001KHz	

- Measuring scope: 40Hz ~ 10kHz
- The input voltage range: ≥ 600mV AC (RMS) (input voltage will increase when the frequency to be measured increases)
- Input impedance: 10MΩ
- Maximum input voltage: 600V AC (RMS)

3.2.5.3 Through grade HZ/DUTY:

Measuring range	Resolution	Accuracy
9.999Hz	0.001Hz	±(0.5% of reading + 3 digits)
99.99Hz	0.01Hz	
999.9Hz	0.1Hz	
9.999KHz	0.001KHz	
99.99KHz	0.01KHz	
999.9KHz	0.1KHz	
9.999MHz	0.001MHz	

- Overload protection: 250V DC or AC (RMS)
- The input voltage range: ≥ 2V (input voltage will increase when the frequency to be measured increases)

AC/DC Clamp Meter

3.2.6 Duty Ratio

Measuring range	Resolution	Accuracy
0.1%-99.9%	0.1%	±(3%+5)

3.2.6.1 Through grade A (from clamp head):

- Frequency response: 40 ~ 1kHz
- Input current range: ≥6AAC (RMS)
- Maximum input current: AC 600A

3.2.6.2 Through grade V:

- Frequency response: 40 ~ 10kHz
- Input voltage range: > 600mV AC
- Input impedance: 10MΩ
- Maximum input voltage: 600V AC (RMS)

3.2.6.2 Through grade HZ/DUTY:

- Frequency response: 1 ~ 10MHz
- The input voltage range: >2V AC (RMS) (input voltage will increase when the frequency to be measured increases)
- Maximum input voltage: 250V AC (RMS)

3.2.7 Resistance

Measuring range	Resolution	Accuracy
600Ω	0.1Ω	±(0.8% of reading + 3 digits)
6kΩ	0.001kΩ	
60kΩ	0.01kΩ	
600kΩ	0.1kΩ	
6MΩ	0.001MΩ	±(1.2% of reading + 3 digits)
60MΩ	0.1MΩ	

- Open circuit voltage: about 0.4V
- Overload protection: 250V DC or AC (RMS)

AC/DC Clamp Meter

3.2.8 Circuit Continuity Test

Measuring range	Resolution	Function
	0.1Ω	If the resistance of circuit to be measured is less than 50±20Ω, the meter's built-in buzzer may sound.

- Overload protection: 250V DC or AC (RMS)

3.2.9 Capacitance

Measuring range	Resolution	Accuracy
40nF	0.01nF	±(4.0% of reading + 5 digits)
400nF	0.1nF	
4μF	0.001μF	
40μF	0.01μF	
400μF	0.1μF	
4000μF	0.001mF	

- Overload protection: 250V DC or AC (RMS)

3.2.10 Diode Test

Measuring range	Resolution	Function
	0.001V	Display approximate diode forward voltage value

- Forward DC current is about 1mA
- Backward DC voltage is about 2.7V
- Overload protection: 250V DC or AC (RMS)

AC/DC Clamp Meter

3.2.11 Temperature

Measuring range	Resolution	Accuracy
-20°C~0°C	1°C	±(3.0% of reading +4°C)
1°C~400°C		±(1.0% of reading +3°C)
401°C~1000°C		±2.0% of reading
-4°F~32°F	1°F	±(3.0% of reading +7°F)
33°F~752°F		±(1.0% of reading +5°F)
753°F~1832°F		±2.0% of reading

- Temperature indicator does not include thermocouple error.
- Overload protection: 250V DC or AC (RMS)

4. Operating Guidance

4.1 Reading Hold

- 1) In the process of measurement, if reading hold is required, press “**HOLD/B.L**” key. The display value in the display will be locked. Press “**HOLD/B.L**” key again to release reading hold.

4.2 NCV Key

NCV key is used for non-contact voltage detection. Press this key and hold it. Place the NCV sensor zone close the conductor to be detected. If voltage is more than AC 90V, NCV indicator will flash and the buzzer will sound at regular intervals.

4.3 Frequency/Duty Ratio Switch

- 1) When the meter is in AC voltage, AC current position, if “**HZ/%**” button is pressed, the meter will measure AC voltage and AC current signal frequency. Click “**HZ/%**” button again, and the meter will measure

AC/DC Clamp Meter

voltage and current signal duty ratio. If it is in HZ/DUTY position, pressing HZ % key will switch between HZ and DUTY.

- 2) If “**HZ/%**” button is pressed again, the meter will revert to voltage, current measurement state.

Note:

When the meter is in the maximum/minimum value measurement state, it can't be switched to frequency, duty ratio measurement mode.

4.4 Maximum/Minimum Measurement Choice

- 1) Press “**MAX/MIN**” key to enter MAX mode, and always store measurement maximum value. Press “**MAX/MIN**” key again, and the meter will enter minimum value measurement state. Press “**MAX/MIN**” key for the third time, and the meter will display the difference of maximum and minimum value. Press “**MAX/MIN**” key to cycle through the above operations.
- 2) After entering MAX or MIN mode, the meter will automatically save the measured maximum or minimum value.
- 3) If the user presses “**MAX/MIN**” key more than 2 sec, the meter will restore normal measuring range.

Note:

- 1) When the meter is in the maximum/minimum value measurement state, it is manual measuring range mode.
- 2) When the meter is in the frequency, duty ratio measurement state, it can't be switched to maximum/minimum value measurement mode.
- 3) When the meter is in the maximum/minimum value measurement state, SEL, REL key is invalid.

AC/DC Clamp Meter

4.5 Function Switch

- 1) In the resistance mode, pressing “SEL” button will switch among resistance, diode, continuity and capacitance detection.
- 2) In the voltage and current mode, pressing “SEL” key will switch between AC and DC.
- 3) In the temperature mode, pressing “SEL” key will switch between Celsius degree and Fahrenheit degree.

4.6 REL Measurement





- 1) REL key is relative value measurement button. When the user taps this button, it will enter relative value measurement mode. The current display value can be stored in the memory as reference value. When the user measures later, the display value is the difference for input value minus reference value. ie. $REL\Delta(\text{current reading}) = \text{Input value} - \text{Reference value}$.
- 2) The relative value measurement can only be performed in the manual measuring mode.

4.7 Back Light And Clamp Head Light

- 1) In the process of measurement, if ambient light is too dark to read, press “B.L/HOLD” key for more than 2 seconds to turn on the backlight. The backlight will automatically turn off in about 10 seconds.
- 2) During this period, pressing “B.L/ HOLD” key more than two seconds will turn off backlight.
- 3) In the current measuring mode, the meter will turn on backlight. At the same time it will turn on clamp head light. Backlight luminophor is LED with high current draw. If backlight is used often, it will shorten battery life. Therefore, use the backlight only when necessary.

AC/DC Clamp Meter



Note:

When battery voltage is $\leq 3.6V$, LCD displays “” (undervoltage) symbol.
But when the user uses the backlight, when the battery voltage frequency is $\geq 3.6V$, battery voltage drops due to its high working current, “” symbol may display. (When “” symbol shows, it does not guarantee the accuracy of measurement). At this time, don't replace the battery. Use the meter normally without using back light, and wait to replace the battery when the “” symbol is displayed.

4.8 Automatic Power-Off

- 1) If there is no operation for 15 minutes after turning the machine on, the meter will automatically power off to save electricity. Within 1 minute before shutdown, the buzzer will sound for five times. Just before powering off, the buzzer will make a long sound.
- 2) After automatic power-off, press any key to restore the meter to ready status.
- 3) Holding the “SEL” key when powering on will cancel automatic power-off function.

4.9 Measurement Preparation

- 1) Turn the transfer switch to turn on the power. When battery voltage is low (about $\leq 3.6V$), LCD displays “” symbol, replace the battery.
- 2) “” symbol means that input voltage or current should not be more than instruction value, which is to protect the internal line from damage.
- 3) Place transfer switch to required measuring function and range.
- 4) When connecting line, please connect the common test line first, then connect charged test line. When removing line, remove charged test line first.

AC/DC Clamp Meter

4.10 Current Measurement



Electric shock hazard.

Remove the probe from the meter before measuring with current clamp.

- 1) When measuring switch is placed to position **A**, the meter is in AC current measurement state. Choose the appropriate measuring range. If you can't determine the size of current to be tested, choose the maximum measuring range, then choose lower ranges until the correct range is displayed. If you want to measure DC current, press **SEL** key to enter DC current measurement state.
- 2) Hold the trigger, open clamp head, and clip one lead of measurement circuit to be tested into the clamp.
- 3) Read the duty ratio value on the LCD display.

Note:

- 1) Clamping two or more leads of circuit to be tested simultaneously will give invalid readings.
- 2) To get accurate readings, place the lead to be tested at the center of clamp head.
- 3) "" indicates that maximum input AC current is 600 A.
- 4) To improve measurement precision, in the DC current measurement state, because the earth and other magnetic fields have an impact on DC current measurement precision, if the LCD display is not zero, place the clamp head vertical to conductor to be measured, then press REL back to zero, then measure.

AC/DC Clamp Meter

4.11 Voltage Measurement



Electric shock hazard.

Pay special attention to avoid shock when measuring high voltage.

Don't input voltage more than AC 600 V RMS.

- 1) Insert black probe to **COM** jack, insert red probe to **INPUT** jack, choose appropriate measuring range.
- 2) Place transfer switch in voltage position **V \approx** At this time, the meter is DC voltage measurement state. To measure AC voltage, press SEL key to enter AC voltage measurement state.
- 3) Connect the probe with voltage source or both ends of load in parallel.
- 4) Read the voltage on the LCD.

Note:

1. In the small voltage measuring range, the probe is not connected with the circuit to be tested, and the meter may have fluctuating readings. This is normal and is caused by the meter's high sensitivity. When the meter is connected with the circuit to be tested, you will get actual measured value.
2. "" indicates that maximum input voltage is 600V AC or 600V DC.
3. If the reading measured by the meter is more than 750V AC or 1000V DC, it will send out "beep" alarm.

AC/DC Clamp Meter

4.12 Frequency And Duty Ratio Measurement

1) Clamp head measuring frequency (through grade current):



Electric shock hazard.
Remove the probe from the meter before measuring with current clamp.

- (1) Place measuring switch in position **A**. Choose appropriate measuring range.
- (2) Hold the trigger, open clamp head, clip one lead of measurement circuit to be tested in the clamp.
- (3) Press "**Hz/%**" key to switch to frequency measuring state.
- (4) Read the current value on the LCD display.
- (5) Pressing "**Hz/%**" again can enter duty ratio measuring state.
- (6) Read the current value on the LCD display.

Note:

- (1) Clamping two or more leads of circuit to be tested simultaneously will give invalid readings
- (2) Frequency measurement range is 40Hz~1kHz
If the frequency to be tested is less than 40Hz, measuring frequency higher than 10 kHz is possible, but accuracy is not guaranteed
- (3) Duty ratio measuring range is 10~95%.
- (4) "**△**" means that maximum input current is 600A AC (RMS).

AC/DC Clamp Meter

2) Through grade voltage:



Electric shock hazard.
Pay special attention to avoid shock when measuring high voltage.
Don't input voltage more than AC 600V RMS.

- (1) Insert black probe to **COM** jack, insert red probe to **INPUT** jack.
- (2) Place transfer switch to **V \approx** position, press SEL to enter AC voltage measurement state.
- (3) Press "**Hz/%**" key to switch to frequency measuring state.
- (4) Connect the probe with signal or both ends of load in parallel
- (5) Read on the LCD.
- (6) Pressing "**Hz/%**" again to enter duty ratio measuring state and read data on the LCD.

Note:

- (1) Frequency measurement range is 10Hz ~ 1kHz
If the frequency to be tested is less than 10Hz, LCD will show "00.0" measuring frequency higher than 10 kHz is possible, but its accuracy is not guaranteed
- (2) Duty ratio measuring range is 10 ~ 95%.
- (3) "**△**" means that maximum input voltage is 600V AC (RMS).

AC/DC Clamp Meter

3) Through grade HZ/DUTY:



Electric shock hazard.

Pay special attention to avoid shock when measuring high voltage.

Don't input voltage more than AC 250V RMS.

- (1) Insert black probe to **COM** jack, insert red probe to **INPUT** jack.
- (2) Place transfer switch in position **HZ**.
- (3) Connect the probe with signal or both ends of load in parallel.
- (4) Read on the LCD.
- (5) Press "**HZ/%**" again to enter duty ratio measuring state.

Note:

Frequency measurement range is 1 Hz~10 MHz. If the frequency to be measured is less than 1 Hz, the LCD will display "00.0".

4.13 Resistance Test



Electric shock hazard.

When measuring circuit impedance, determine that the power supply is disconnected and the capacitor in the circuit is completely discharged.

- 1) Insert black probe to **COM** jack, insert red probe to **INPUT** jack.
- 2) Place measuring range switch to $\rightarrow \Omega$ position. At time, the meter is in the measurement state.
- 3) Connect the probe to the both ends of resistor or circuit to be tested..
- 4) LCD will show readings.

AC/DC Clamp Meter

Note:

- 1) When the input end is open, LCD shows "0L" over-range state.
- 2) When the resistance to be tested is $> 1M\Omega$, the meter reading will stabilize after a few seconds, which is normal for high resistance readings.

4.14 Diode Test

- 1) Insert black probe to **COM** jack, insert red probe to **INPUT** jack.
- 2) Place measuring switch in $\rightarrow \Omega$ position.
- 3) Press "**SEL**" button to switch to $\rightarrow \rightarrow$ measuring state.
- 4) Connect the red probe to diode anode and connect the black probe to diode cathode to make test.
- 5) Readings will display on the LCD.

Note:

- 1) What the meter shows is approximation of diode forward voltage drop.
- 2) If the probe has reverse connection or the probe is open, the LCD will show "0L".

4.15 Circuit Continuity Test



Electric shock hazard.

When measuring circuit continuity, determine that the power supply is disconnected and the capacitor in the circuit is completely discharged.

- 1) Insert black probe to **COM** jack, insert red probe to **INPUT** jack.
- 2) Measuring switch is placed to $\rightarrow \Omega$ position.
- 3) Press "**SEL**" key to switch to $\rightarrow \rightarrow$ circuit continuity measuring state.

AC/DC Clamp Meter

- 4) Connect the probe to the both ends of circuit to be tested.
- 5) If the resistance of circuit to be measured is less than $50 \pm 20\Omega$, the meter's built-in buzzer may sound.
- 6) Read the circuit resistance value on the LCD.

Note:

If the probe is open or circuits resistance to be tested is more than 600Ω , the display will show "OL".

4.16 Capacitance Measurement



Electric shock hazard.

To avoid electric shock, before measuring capacitance, discharge capacitance completely.

- 1) Insert black probe to **COM** jack, insert red probe to **INPUT** jack.
- 2) Measuring switch is placed to $\frac{\Omega}{\mu F}$ position
- 3) Press "**SEL**" button three times to switch to capacitance measuring state.
- 3) After discharging capacitance completely, connect the probe to the both ends of capacitor to be tested for measurement.
- 4) Read the capacitance on the LCD.

Note:

- 1) When measuring bulk capacitor, readings will stabilize after a few seconds ($400\mu F$ and $4000\mu F$).
- 2) To improve the accuracy below $40nF$ measuring value, subtract the distributed capacitance of meter and cable.

AC/DC Clamp Meter

4.17 NCV Measurement

- 1) Press NCV key. .
- 2) Place the NCV sensor zone close to the conductor. When test voltage is greater than AC 110V (RMS), when the meter is close to the conductor, the meter induction voltage indicator will turn on and buzzer will sound.

Note:

- 1: Even there is no indication, voltage may exist still. Don't use non-contact voltage detector to judge whether there is voltage in the wire. Detection operation could be affected by socket design, insulation thickness, type and other factors.
- 2: When inputting voltage on the meter input terminal, due to the existence of the induced voltage, voltage induction indicator also may light.
- 3: Interference sources of external environment (such as flashlight, motor, etc.) may trigger invalid non-contact voltage detection.

4.18 Temperature Measurement

- 1) Insert black probe to COM jack, insert red probe to INPUT jack.
- 2) Rotate switch to "TEMP" position. Normal temperature will show on the LCD display simultaneously.
- 3) Insert K-type thermocouple to the input jack of the meter with correct polarity (insert red one to INPUT jack, and insert black one to COM jack).
- 4) Measure the inner and outer surfaces of object to be tested with the measuring end of thermocouple.
- 5) Read the measuring value from LCD display.

AC/DC Clamp Meter

5. Maintenance

5.1 Replace Battery

 **WARNING**

To avoid electric shock, make sure that the test leads have been clearly move away from the circuit under measurement before opening the battery cover of the meter.

 **WARNING**

Do not mix old and new batteries. Do not mix alkaline, standard (carbon-zinc), or rechargeable (ni-cad, ni-mh, etc) batteries.

- 5.1.1 If the sign “” appears, it means that the batteries should be replaced.
- 5.1.2 Loosen the fixing screw of the battery cover and remove it.
- 5.1.3 Replace the exhausted batteries with new ones.
- 5.1.4 Put the battery cover back and fix it again to its origin form.

Note:

Do not reverse the polarity of the batteries.

5.2 Replacing Test Leads

Replace test leads if leads become damaged or worn.

 **WARNING**

Use meet EN 61010-031 standard, rated CAT III 600V, or better test leads.

 **WARNING**

To avoid electric shock,make sure the probes are disconnected from the measured circuit before removingthe rear cover. Make sure the rear cover is tightly screwed before using the instrument.

AC/DC Clamp Meter

6. Accessories

- | | |
|---------------------|-------|
| 1) Test leads | 1pair |
| 2) User Manual | 1pcs |
| 3) 1.5V AAA Battery | 3pcs |

